

SYSTEMATIC QUALITY

# Mobile distribution boxes



Catalogue



## Mobile distributor boxes, hard rubber

Pages 3-11

Introduction



Page 3

RCCB- and personal safety adapters



Page 4

Small mobile distributor boxes



Pages 5-6

Mobile floor distributor boxes

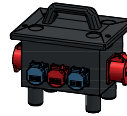

Pages 7-8

Mobile wall-mounted distributor boxes



Pages 9-10

Standard accessories for mobile distributor boxes



Page 11

## Safety and isolating transformers

Pages 12-13

Isolating transformers 230/230V

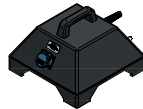

Page 12

Safety transformers 24V



Page 13

## Power distribution trolley

Page 14

Power distribution trolley



Page 14

## Practical examples

Page 15

Practical examples



Page 15



## Small mobile distributor boxes

Small mobile distributor boxes from GIFAS-ELECTRIC are really hard to beat in terms of their compact design. The standard range shown meets different needs and fulfils different regulations (accident prevention).

For various uses in site maintenance, in industry or on a construction site, you can rely on our small mobile distributor boxes to meet the toughest requirements. When using these devices you will have taken all the protection and safety measures required for power distribution.

## Mobile floor distributor boxes

The mobile floor distributor boxes range was designed for more complex, temporary construction sites. Varied component fitting options, robust casing design and a design matched to fit the application are the main features of this range.

With the mobile floor distributor boxes from GIFAS-ELECTRIC you get a long and durable service life with low maintenance requirements, even under the most extreme conditions. All requirements in terms of safety are also met in full.

## Mobile wall-mounted distributor boxes

The range of mobile wall-mounted distributor boxes was developed for large-scale power supply purposes. This group features varied component fitting options, practical handling (handle, brackets), various combination options and practical accessories.

For regular events in particular such as markets, trade fairs, events, construction sites, etc. finely graded installations can be created in a very short space of time.

Make use of our wide range of experience in designing your mobile distribution system.

## Customised solutions – our strength!

The products given below are provided as examples of the many bespoke solutions available to meet customer requirements.

## One consultancy – one supplier – GIFAS-ELECTRIC

### Mobile distributor boxes from GIFAS...

- ... made from vulcanised butyl rubber (hard rubber)
- ... the solution to aggressive environmental influences
- ... with customised component fitting options
- ... with guaranteed high service life

## The solution to your power distribution needs!

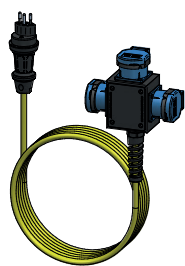

Item no. 228521

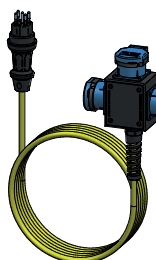

Item no. 228508

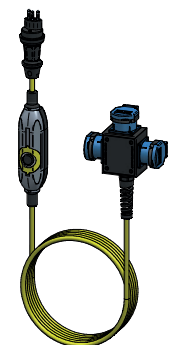

Item no. 229353

## Small distributor boxes, Small distributor boxes with personal protection (RCCB), IP55

Item no.	Symbol output	Output	Input Cable / plug	Line protection LP / Personal protection (RCCB)
✓ 228506		3×T13	5m, 3×1.5mm <sup>2</sup> T13	Pre-fuse max. 13A
✓ 228521		3×T13	10m, 3×1.5mm <sup>2</sup> T13	Pre-fuse max. 13A
✓ 228508		3×T13	5m, 5×1.5mm <sup>2</sup> T15	Pre-fuse max. 13A
228523		3×T13	10m, 5×1.5mm <sup>2</sup> T15	Pre-fuse max. 13A
229351 <sup>1)</sup>		3×T13 2.5m, 3×1.5mm <sup>2</sup>	0.5m, 3×1.5mm <sup>2</sup> T13	Personal safety control unit 16A/30mA
229352 <sup>1)</sup>		3×T13 4.5m, 3×1.5mm <sup>2</sup>	0.5m, 3×1.5mm <sup>2</sup> T13	Personal safety control unit 16A/10mA
229353 <sup>1)</sup>		3×T23 4.5m, 3×1.5mm <sup>2</sup>	0.5m, 3×1.5mm <sup>2</sup> T23	Personal safety control unit 16A/30mA

<sup>1)</sup> Version with special personal safety control unit, integrated into the cable:  
230V/16A with 10mA or 30mA trigger range/IP55, with ON and OFF buttons and visual switch position display/  
undervoltage trigger

Item no.	Cable	Output	Input Cable / plug	Line protection LP / Personal protection (RCCB)
<b>Special devices, RCCB adapter cable, Personal safety adapter cable</b>				
✓ 229354 <sup>1)</sup>	Proflex 3×1.5mm <sup>2</sup> /2m	Hard rubber socket T13 1.5m	Hard rubber plug T13 0.5m	Personal safety control unit 16A/30mA
229355 <sup>1)</sup>	Proflex 3×1.5mm <sup>2</sup> /2m	Hard rubber socket T23 1.5m	Hard rubber plug T23 0.5m	Personal safety control unit 16A/30mA

<sup>1)</sup> Version with special personal safety control unit, integrated into the cable:  
230V/16A with 10mA or 30mA trigger range/IP55, with ON and OFF buttons and visual switch position display/  
undervoltage trigger

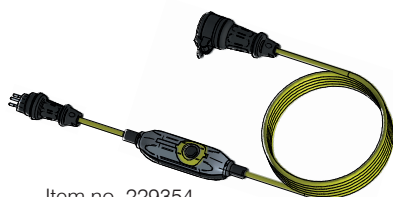

Item no. 229354

# Small mobile distributor boxes, hard rubber



Item no. 229361



Item no. 229367



Item no. 229373

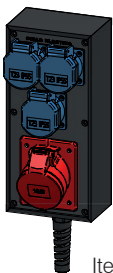

Item no. 229377

Item no.	Symbol output	Output	Input Cable / plug	Line protection LP/Personal protection (RCCB)
<b>Type 1400 – 78×290×65 mm (91), IP55</b>				
✓ 229361 <sup>1)</sup>		2×T13	5m, 3×1.5mm <sup>2</sup> T13	1×1N-25A/30mA
✓ 229362 <sup>2)</sup>		2×T13	5m, 3×1.5mm <sup>2</sup> T13	1×1N-25A/30mA
229364 <sup>1)</sup>		2×T23	5m, 3×1.5mm <sup>2</sup> T23	1×1N-25A/30mA
✓ 229365 <sup>2)</sup>		2×T23	5m, 3×1.5mm <sup>2</sup> T23	1×1N-25A/30mA
✓ 229366 <sup>1)</sup>		4×T13	5m, 3×1.5mm <sup>2</sup> T13	Pre-fuse max. 13A
✓ 229367 <sup>2)</sup>		4×T13	5m, 3×1.5mm <sup>2</sup> T13	Pre-fuse max. 13A
229369 <sup>1)</sup>		4×T23	5m, 3×1.5mm <sup>2</sup> T23	Pre-fuse max. 16A
✓ 229370 <sup>2)</sup>		4×T23	5m, 3×1.5mm <sup>2</sup> T23	Pre-fuse max. 16A
236693		3×T23 1×T25	5m, 5×1.5mm <sup>2</sup> T25	Pre-fuse max. 16A

<sup>1)</sup> with reel unit

<sup>2)</sup> with suspension plug V2A

## Type 1600 – 82×200×64 mm, IP55

✓ 229373		3×T23	5m, 3×1.5mm <sup>2</sup> T23	Pre-fuse max. 16A
✓ 229374		1×T13 2×T15	5m, 5×1.5mm <sup>2</sup> T15	Pre-fuse max. 13A

## Type 2612 – 120×260×76 mm, IP55

229375		6×T13	5m, 3×1.5mm <sup>2</sup> T13	Pre-fuse max. 13A
229376		6×T23	5m, 3×1.5mm <sup>2</sup> T23	Pre-fuse max. 16A

## Type 2612 – 120×260×76 mm, IP44

✓ 229377		3×T23 1×CEE 16/5	5m, 5×1.5mm <sup>2</sup> CEE 16/5	Pre-fuse max. 16A
041437		1×CEE 16/3 1×CEE 16/5	5m, 5×1.5mm <sup>2</sup> CEE 16/5	Pre-fuse max. 16A

Type 1400

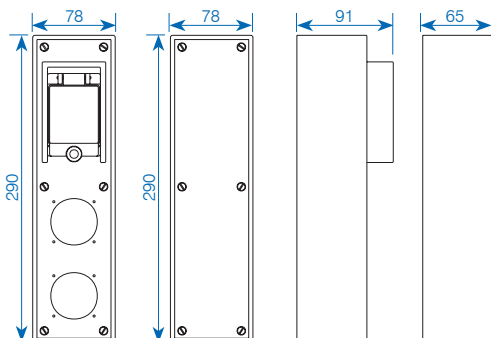

Type 1600

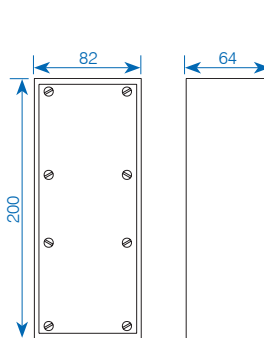

Type 2612

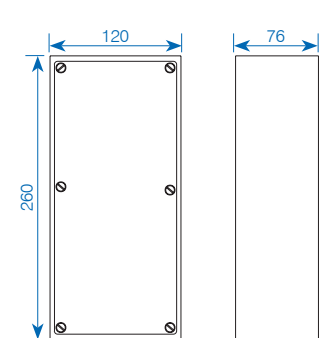

Other fitting options on request.  
✓ From stock, offer subject to prior sale

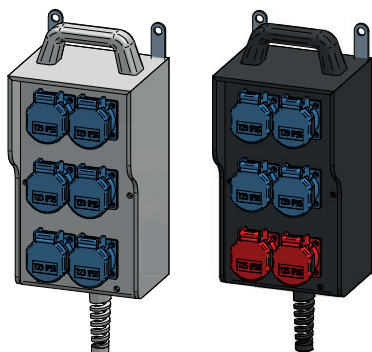

Item no. 229448

Item no. 232346

Item no.	Symbol output	Output	Input Cable / plug	Line protection LP / Personal protection (RCCB)
<b>Type 7250 – 160×280×133 mm, IP55</b>				
229447		6×T13	5 m, 5×1.5 mm <sup>2</sup> T15	Pre-fuse max. 13 A
✓ 229448		6×T23	5 m, 5×1.5 mm <sup>2</sup> CEE 16/5	Pre-fuse max. 16 A
232346		4×T23 2×T25	5 m, 5×1.5 mm <sup>2</sup> CEE 16/5	Pre-fuse max. 13 A

mit Griff und Aufhängelassen

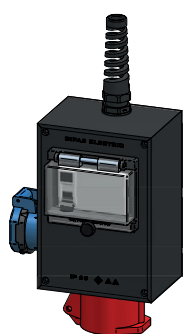

Item no. 229450

**Type 1812 – 180×125×90 mm, IP44**

✓ 229450		1×T23 1×CEE 16/5	3 m, 5×1.5 mm <sup>2</sup> CEE 16/5	Pre-fuse max. 16 A 1×3N-40A/30 mA
----------	--	---------------------	-------------------------------------	--------------------------------------

**Type 1812 – 180×125×90 mm, IP55**

229451		2×T15	3 m, 5×1.5 mm <sup>2</sup> T15	Pre-fuse max. 13 A 1×3N-40A/30 mA
--------	--	-------	--------------------------------	--------------------------------------

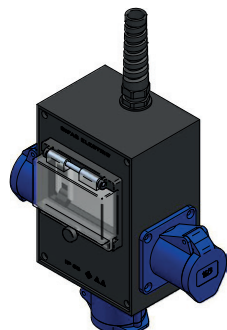

Item no. 041568

**Type 1812 – 180×125×90 mm, IP55**

229452		2×T13 1×T15	3 m, 5×1.5 mm <sup>2</sup> T15	Pre-fuse max. 13 A 1×3N-40A/30 mA
--------	--	----------------	--------------------------------	--------------------------------------

**Type 1812 – 180×125×90 mm, IP44**

229453		2×T23 1×CEE 16/3	3 m, 5×1.5 mm <sup>2</sup> CEE 16/5	Pre-fuse max. 16 A 1×3N-40A/30 mA
041568		3×CEE 16/3	3 m, 5×1.5 mm <sup>2</sup> CEE 16/5	Pre-fuse max. 16 A 1×3N-40A/30 mA

Type 7250

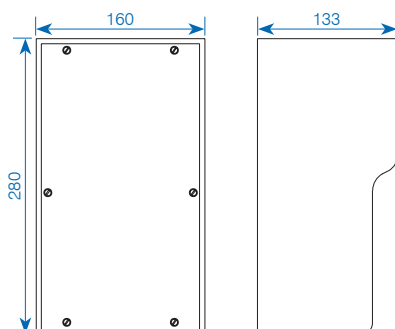

Type 1812

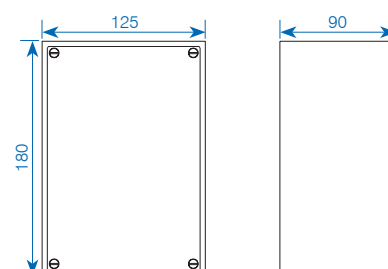

Other fitting options on request.

✓ From stock, offer subject to prior sale

# Mobile floor distributor boxes, hard rubber

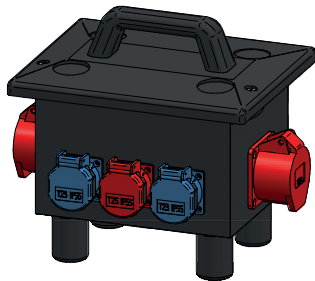

Item no. 229457

Item no.	Symbol output	Output	Input Cable / plug	Line protection LP/Personal protection (RCCB)
----------	---------------	--------	--------------------	---

## Type 6200 – 280×223×230 mm, IP55

229454		8×T23	5 m, 5×1.5mm <sup>2</sup> Type 25	Pre-fuse max. 16A
229455		6×T23 1×T25	10 m, 5×2.5mm <sup>2</sup> CEE 16/5	Pre-fuse max. 16A 1×3N-40A/30mA

## Type 6200 – 280×223×230 mm, IP44

229456		4×T23 1×CEE 16/3 1×CEE 16/5	5 m, 5×1.5mm <sup>2</sup> CEE 16/5	Pre-fuse max. 16A 1×3N-40A/30mA
✓ 229457		2×T23 1×T25 2×CEE 16/5	5 m, 5×2.5mm <sup>2</sup> CEE 16/5	Pre-fuse max. 16A 1×3N-40A/30mA
✓ 229459		3×T23 2×CEE 16/5	5 m, 5×4.0mm <sup>2</sup> CEE 32/5	Pre-fuse max. 32A 1×3N-40A/30mA 3×1-16A "C" 1×3-16A "C"
229460		3×T23 3×T25 1×CEE 16/5	Built-in plug CEE 16/5	Pre-fuse max. 16A

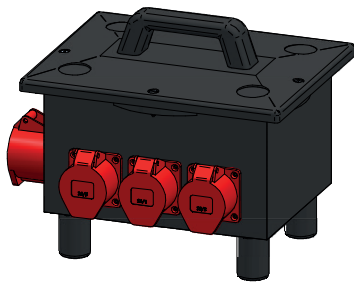

Item no. 229461

## Type 6700 – 350×253×280 mm, IP44

✓ 229461		2×T23 2×T25 3×CEE 16/5 1×CEE 32/5	3 m, 5×4.0mm <sup>2</sup> CEE 32/5	Pre-fuse max. 32A 1×3N-40A/30mA 1×1-16A "C" 2×3-16A "C"
✓ 236679		3×T23 1×T25 2×CEE 16/5 2×CEE 32/5	5 m, 5×10.0mm <sup>2</sup> CEE 63/5	Pre-fuse max. 63A 1×3N-63A/30mA 2×3-16A "C" 1×3-32A "C"
229463		6×T25 3×CEE 16/5	Built-in plug CEE 63/5	Pre-fuse max. 63A 1×3N-63A/30mA 4×3-16A "C"
✓ 050408		3×CEE 32/5	Built-in plug CEE 63/5	Pre-fuse max. 63A 1×3N-63A/30mA 3×3-32A "C"

Type 6200

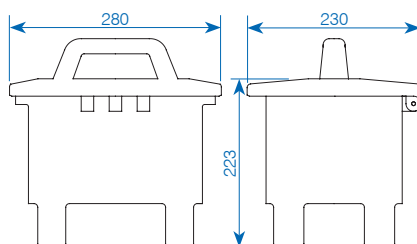

Type 6700

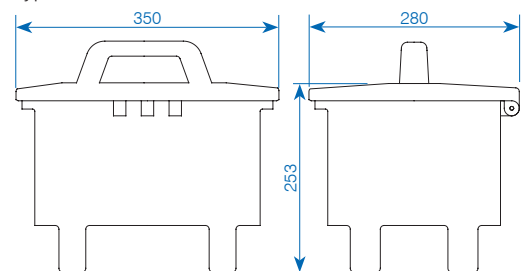

Stackable (raised feet). Other fittings options on request.

✓ From stock, offer subject to prior sale

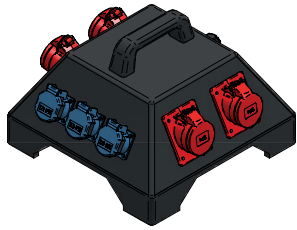

Item no. 229649

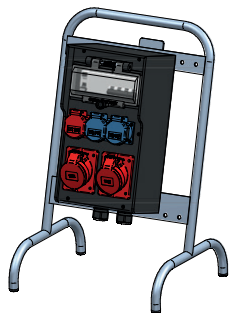

Item no. 229652

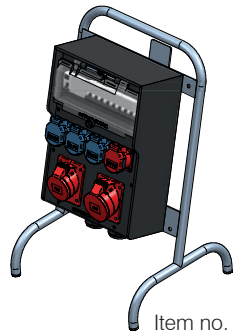

Item no. 229653

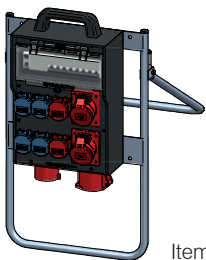

Item no. 228745

Item no.	Symbol output	Output	Input Cable/plug	Line protection LP/Personal protection (RCCB)
----------	---------------	--------	------------------	---

**Type 3500 – 364×350×249 mm, IP55**

229647		12×T23	5m, 5×4.0mm <sup>2</sup> CEE 32/5	Pre-fuse max. 32A 1×3N-40A/30mA 12×1-16A "C"
--------	--	--------	--------------------------------------	--

**Type 3500 – 364×350×249 mm, IP44**

229648		12×T23 2×CEE 16/3	5m, 5×4.0mm <sup>2</sup> CEE 32/5	Pre-fuse max. 32A 1×3N-40A/30mA 14×1-16A "C"
✓ 229649		3×T23 4×CEE 16/5	5m, 5×4.0mm <sup>2</sup> CEE 32/5	Pre-fuse max. 32A 1×3N-40A/30mA 2×1-16A "C" 1×3-16A "C"
229650		3×T23 1×CEE 16/3 2×CEE 16/5 2×CEE 32/5	5m, 5×10.0mm <sup>2</sup> CEE 63/5	Pre-fuse max. 63A 1×3N-63A/30mA 2×1-16A "C" 1×3-16A "C" 1×3-32A "C"
229651		4×T23 4×CEE 16/5 1×CEE 32/5	5m, 5×10.0mm <sup>2</sup> CEE 63/5	Pre-fuse max. 63A 1×3N-63A/30mA 3×3-16A "C" 1×3-32A "C"

**Type 7300 – on stand 583×380×320 mm, IP44**

✓ 229652		2×T23 1×T25 2×CEE 16/5	2 cable glands M25 1×tb 5×16	Pre-fuse max. 60A 1×3N-40A/30mA 1×1-16A "C" 1×3-16A "C"
----------	--	------------------------------	------------------------------------	--

**Type 7400 – on stand 583×380×320 mm, IP44**

✓ 229653		3×T23 1×T25 1×CEE 16/5 1×CEE 32/5	2 cable glands M32 1×tb 5×16	Pre-fuse max. 80A 1×3N-63A/30mA 2×3-16A "C" 1×3-32A "C"
----------	--	--	------------------------------------	--

**Type 7400 – on stand 650×400×251 mm, IP44**

✓ 228745		4×T23 2×T25 2×CEE 16/5 1×CEE 32/5	Built-in plug 32/5A	1×3N-40A/30mA 2×1-16A "C" 2×3-16A "C"
247601 <sup>1</sup>		4×T23 2×T25 2×CEE 16/5 1×CEE 32/5	Built-in plug 32/5A	1×3N-40A/30mA 2×1-16A "C" 2×3-16A "C"

Type 3500

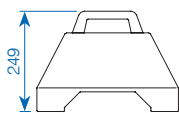
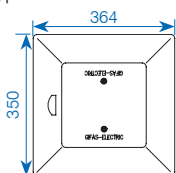

Type 7300

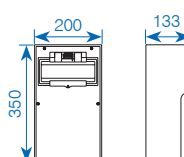

Type 7400

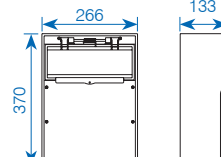

<sup>1</sup> outlet CEE 32/5 not via FI, according to SNG 491000-2071e

Other fittings options on request. For accessories such as stands, brackets, etc. see page 11.

✓ From stock, offer subject to prior sale



# Mobile wall-mounted distributor boxes, hard rubber

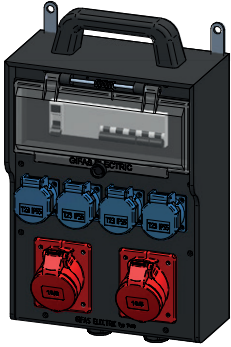

Item no. 229660

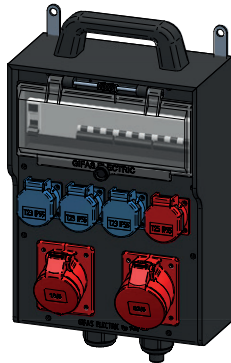

Item no. 229661

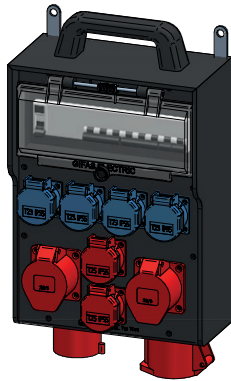

Item no. 228747

Item no.	Symbol output	Output	Input Cable/plug	Line protection LP/Personal protection (RCCB)
<b>Type 7300 – 200×350×133 mm, IP55</b>				
229655		3×T23 3×T25	1 cable gland M32	Pre-fuse max. 40A 1×3N-40A/30mA 1×1-16A "C" 1×3-16A "C"
229656		3×T23 3×T25	5m, 5×4.0 mm <sup>2</sup> CEE 32/5	Pre-fuse max. 32A 1×3N 40A/30mA 1×1-16A "C" 1×3-16A "C"
<b>Type 7300 – 200×350×133 mm, IP44</b>				
✓ 229657		2×T23 1×T25 2×CEE 16/5	2 cable gland M25	Pre-fuse max. 40A 1×3N-40A/30mA 1×1-16A "C" 1×3-16A "C"
229658		2×T23 1×CEE 16/3 1×CEE 16/5 1×CEE 32/5	5m, 5×4.0 mm <sup>2</sup> CEE 32/5	Pre-fuse max. 32A 1×3N-40A/30mA 1×1-16A "C" 1×3-16A "C"
✓ 229659		2×T23 1×T25 1×CEE 16/5 1×CEE 32/5	1 cable gland M32	Pre-fuse max. 32A 1×3N-40A/30mA 1×1-16A "C" 1×3-16A "C"
<b>Type 7400 – 266×370×133 mm, IP44</b>				
229660		4×T23 2×CEE 16/5	2 cable glands M25	Pre-fuse max. 40A 1×3N-40A/30mA 2×1-16A "C" 1×3-16A "C"
✓ 229661		3×T23 1×T25 1×CEE 16/5 1×CEE 32/5	2 cable glands M32	Pre-fuse max. 63A 1×3N-63A/30mA 2×3-16A "C" 1×3-32A "C"
✓ 229662		2×T23 2×T25 2×CEE 16/5 1×CEE 32/5	Built-in plug CEE 32/5A	Pre-fuse max. 32A 1×3N-40A/30mA 2×3-16A "C"
229665		3×T23 1×CEE 16/3 2×CEE 16/5 1×CEE 32/5	5m, 5×10.0 mm <sup>2</sup> CEE 63/5	Pre-fuse max. 63A 1×3N-63A/30mA 3×1-16A "C" 1×3-16A "C" 1×3-32A "C"
✓ 228746		4×T23 2×T25 2×CEE 16/5 1×CEE 32/5	1 cable gland M32	Pre-fuse max. 32A 1×3N-40A/30mA 2×1-16A "C" 2×3-16A "C"
✓ 228747		4×T23 2×T25 2×CEE 16/5 1×CEE 32/5	Built-in plug CEE 32/5A	Pre-fuse max. 32A 1×3N-40A/30mA 2×1-16A "C" 2×3-16A "C"

Type 7300

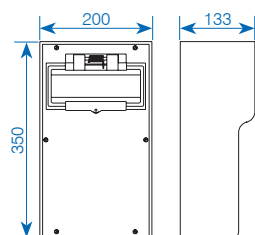

Type 7400

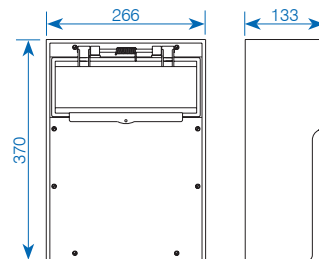

Other fittings options on request. For accessories such as stands, brackets, etc. see page 11.

✓ From stock, offer subject to prior sale

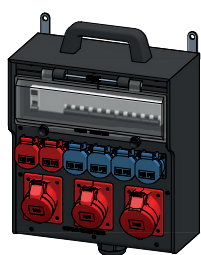

Item no. 229690

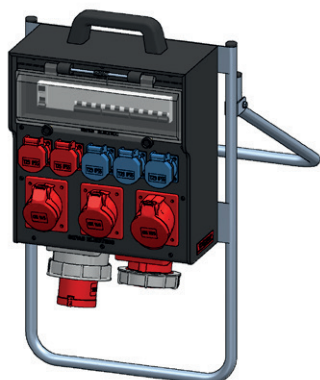

Item no. 247602



Item no. 229697

Type 7700

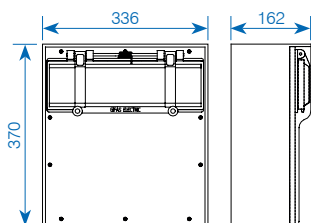

Type 7800

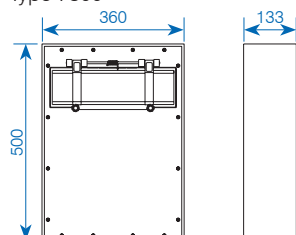

Item no.	Symbol output	Output	Input Cable/plug	Line protection LP/ Personal protection (RCCB)
<b>Type 7700 – 336×370×162 mm, IP44</b>				
✓ 229689		4×T23 2×T25 2×CEE 16/5 1×CEE 32/5	5m, 5×4.0mm <sup>2</sup> CEE 32/5	Pre-fuse max. 32A 1×3N-40A/30mA 2×3-16A "C"
✓ 229690		4×T23 2×T25 2×CEE 16/5 1×CEE 32/5	5m, 5×10.0mm <sup>2</sup> CEE 63/5	Pre-fuse max 63A 1×3N-63A/30mA 2×1-16A "C" 2×3-16A "C" 1×3-32A "C"
✓ 229691		3×T23 2×T25 2×CEE 16/5 1×CEE 32/5 1×CEE 63/5	2 cable glands M40 1×tb 5×16	Pre-fuse max 63A 1×3N-63A/30mA 2×3-16A "C" 1×3-32A "C" FI 63A/300mA
✓ 229692		3×T23 2×T25 2×CEE 16/5 1×CEE 32/5 1×CEE 63/5	Built-in plug CEE 63/5	Pre-fuse max 63A 1×3N-63A/30mA 1×1-16A "C" 2×3-16A "C" 1×3-32A "C" FI 63A/300mA
✓ 247602 <sup>1</sup>		3×T23 2×T25 2×CEE 16/5 1×CEE 32/5 1×CEE 63/5	Built-in plug CEE 63/5	Pre-fuse max 63A 1×3N-63A/30mA 1×1-16A "C" 2×3-16A "C" 1×3-32A "C"
229693		2×T23 2×T25 2×CEE 16/5 1×CEE 32/5 1×CEE 63/5	Built-in plug CEE 63/5	Pre-fuse max 63A 1×3N-63A/30mA 1×1-16A "C" 2×3-16A "C" 1×3-32A "C" FI 63A/300mA
247644 <sup>1</sup>		2×T23 2×T25 2×CEE 16/5 2×CEE 32/5 1×CEE 63/5	Built-in plug CEE 63/5	Pre-fuse max 63A 1×3N-63A/30mA 1×1-16A "C" 2×3-16A "C" 2×3-32A "C"
<b>Type 7800 – 360×500×133 mm, IP44</b>				
✓ 229694		8×T23 2×CEE 16/5 2×CEE 32/5	5m, 5×10.0mm <sup>2</sup> CEE 63/5	Pre-fuse max. 63A 1×3N-63A/30mA 4×3-16A "C" 1×3-16A "C" 2×3-32A "C"
229695		8×T23 2×T25 2×CEE 16/5 1×CEE 32/5	5m, 5×10.0mm <sup>2</sup> CEE 63/5	Pre-fuse max. 63A 1×3N-63A/30mA 1×1-16A "C" 12×3-16A "C" 1×3-32A "C"
229696		4×T23 3×CEE 16/5 1×CEE 32/5 1×CEE 63/5	5m, 5×10.0mm <sup>2</sup> CEE 63/5	Pre-fuse max. 63A 1×3N-63A/30mA 2×1-16A "C" 2×3-16A "C" 1×3-32A "C" FI 63A/300mA
✓ 229697		4×T23 3×CEE 16/5 1×CEE 32/5 1×CEE 63/5	Built-in plug CEE 63/5	Pre-fuse max. 63A 1×3N-63A/30mA 2×1-16A "C" 2×3-16A "C" 1×3-32A "C" FI 63A/300mA

<sup>1</sup> outlet CEE 63/5 not via FI, according to SNG 491000-2071e

Other fittings options on request. For accessories such as stands, brackets, etc. see page 11.

✓ From stock, offer subject to prior sale

# Standard accessories for mobile distributor boxes

## Mini/Maxi stand



## Mini/Maxi stand

Item no.	Designation	Note
✓ 040509	Mini stand for Type 7300-7700	H = 590 mm, zinc-plated
✓ 058258	Maxi stand for Type 7800/7900	H = 755 mm, zinc-plated

## Stand

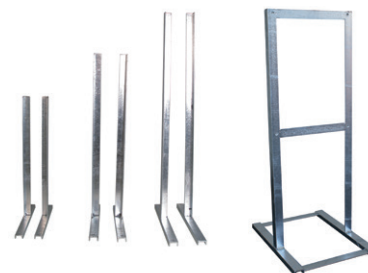

## Stand pairs

Item no.	Designation	Note
✓ 011412	Stand pairs, zinc-plated	H = 600 mm
✓ 011413	Stand pairs, zinc-plated	H = 800 mm
✓ 011414	Stand pairs, zinc-plated	H = 1'000 mm



## Stand foldable

Item no.	Designation
✓ 113103	Stand V2A glass blasted, foldable H = 645 mm, for box types 7200/7300/7400/7700

## Stand

Item no.	Designation	Note
✓ 031713	Frame complete for distributor types 7700	H = 800 mm
014208	Frame complete for distributor types 7800/7900	H = 800 mm
✓ 012600	Frame complete for distributor types 7800/7900	H = 1'000 mm
027622	frame complete for 7800/7900	H = 1'100 mm

## Carrying handle/Cable reel/Switch-disconnector



## Carrying handle/Cable reel/Switch-disconnector

Item no.	Designation	Note
✓ 011390	Carrying handle hard rubber	large
✓ 010768	Carrying handle hard rubber	small
✓ 040165	Cable reel for small distributor boxes	fits all casings (Minimum order quantity: 2)
229800	Switch-disconnector	Size DIN 000/00/0/1/2/3/4
✓ 041089	Knurled screw A2	for type 6200/6700
✓ 041093	Locking ring	to Item no. 041089

## Uni-Stand/bracket/roller foot



## Uni stand

Item no.	Designation	Note
✓ 015473	Uni stand	H = 800 mm, zinc-plated
✓ 022259	Uni stand	H = 1'000 mm, zinc-plated
✓ 043495	Uni bracket for type 7300	zinc-plated
✓ 043497	Uni bracket for type 7400	zinc-plated
✓ 051006	Uni bracket for type 7700/7800	zinc-plated
✓ 043357	Roller foot for stand 800 mm	zinc-plated
✓ 043991	Roller foot for stand 1'000 mm	zinc-plated

We would be pleased to manufacture other designs for you on request.

✓ From stock, offer subject to prior sale

## Safety in the workplace

Many places of work require special electrical products that offer the user the greatest degree of safety.

In many cases the solution for personal protection is the use of safety and isolating transformers.

Thanks to their mechanical and electrical properties, GIFAS hard rubber safety distributor boxes are ideal for use as transformer casings.

From mobile distributor boxes, to wallmounted distributor boxes through to inspection vehicles, we supply any design you need.

Our ready-made hard rubber casing transformers offer:

- transformers conform to EN 61558 (VDE 0570)
- safety isolation to VDE 0100, Part 410
- easy-to-service units, all parts can be individually replaced
- type tested to EN 61439 (CENELECCCA) with individual outgoing check (visual inspection with test log)

## Dimensions table for transformers

S	U <sub>N</sub>	1-phase			3-phase		
		24V	42V	230V	3×42V	3×400V	3×500V
120VA	I <sub>n</sub> P <sub>m</sub>	5.0A 92W	2.9A 92W	0.5A 92W			
320VA	I <sub>n</sub> P <sub>m</sub>	13.3A 246W	7.6A 246W	1.4A 246W			
500VA	I <sub>n</sub> P <sub>m</sub>	20.8A 385W	12A 385W	2.2A 385W			
1.0kVA	I <sub>n</sub> P <sub>m</sub>	41.7A 770W	23.8A 770W	4.3A 770W			
1.5kVA	I <sub>n</sub> P <sub>m</sub>	62.5A 1'155W	35.7A 1'155W	6.5A 1'155W	20.6A 1'155W		
2.0kVA	I <sub>n</sub> P <sub>m</sub>	83.3A 1'540W	47.6A 1'540W	8.7A 1'540W	27.5A 1'540W	2.9A 1'540W	2.3A 1'540W
2.5kVA	I <sub>n</sub> P <sub>m</sub>	104.2A 1'925W	59.5A 1'925W	10.9A 1'925W	34.4A 1'925W	3.6A 1'925W	2.9A 1'925W

S = apparent power (transformer output)

I<sub>n</sub> = rated current of the transformer

P<sub>m</sub> = motor output that can be connected at (cos.=0.77)

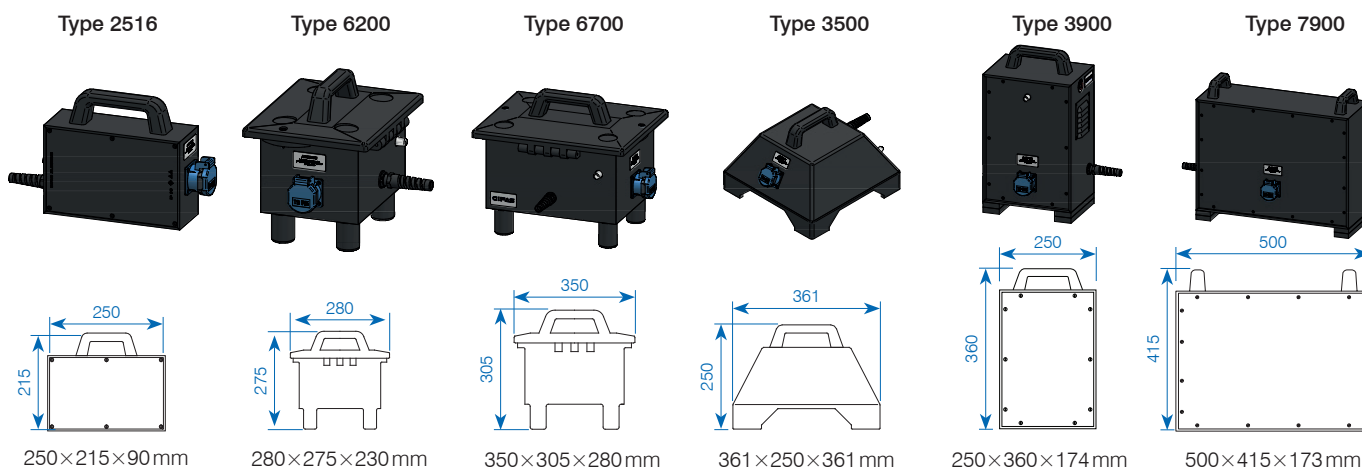

## Mobile isolating transformers 230/230V, protection category IP54, protection class II

Item no.	Output VA	Type	Symbol output	Output	Input	Interior fittings	Safety devices	
							Primary	Secondary
229703	120	2516		1×built-in socket T13 no protective conductor	3m, 2×1.5mm <sup>2</sup> with plug T13	1 thermal overcurrent protection switch	0.6A	
229704	320	6200		1×built-in socket T13 no protective conductor	3m, 2×1.5mm <sup>2</sup> with plug T13	1 thermal overcurrent protection switch	1.6A	
229706	500	6200		1×built-in socket T13 no protective conductor	3m, 2×1.5mm <sup>2</sup> with plug T13	1 thermal overcurrent protection switch	2.5A	
229707	1'000	6700		1×built-in socket T13 no protective conductor	3m, 2×1.5mm <sup>2</sup> with plug T13	1 thermal overcurrent protection switch	5.0A	
229708	1'500	3500		1×built-in socket T13 no protective conductor	3m, 2×1.5mm <sup>2</sup> with plug T13	1 thermal overcurrent protection switch	7.5A	
229709	2'000	3500		1×built-in socket T13 no protective conductor	3m, 2×1.5mm <sup>2</sup> with plug T13	1 thermal overcurrent protection switch	10.0A	
229710	2'500	3900		1×built-in socket T13 no protective conductor	3m, 2×1.5mm <sup>2</sup> with plug T13	1 thermal overcurrent protection switch 1 start-up current limiter	12.0A	
229711	3'500	7900		1×built-in socket T23 no protective conductor	3m, 2×1.5mm <sup>2</sup> with plug T23	1 thermal overcurrent protection switch 1 start-up current limiter	16.0A	

Other fitting options on request. For accessories such as stands, brackets, etc. see page 11.

# Safety transformers 24 V

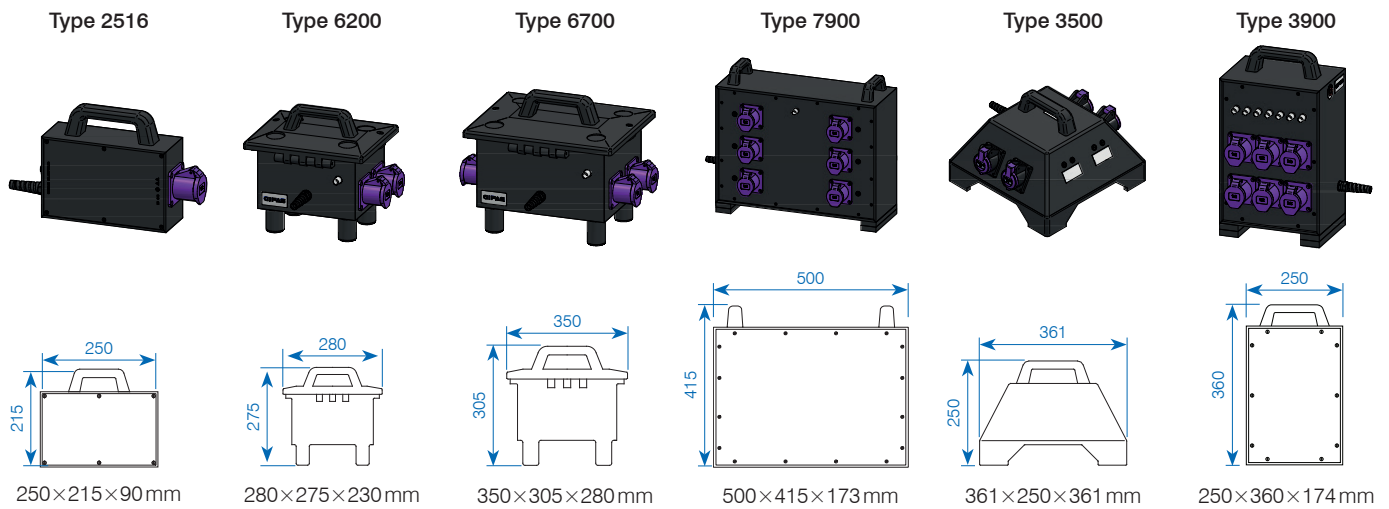

## Mobile safety transformers 230/24 V, protection category IP44, protection class II

Item no.	Output VA	Type	Symbol Output	Output	Input	Interior fittings	Safety devices	
							Primary	Secondary
229712	120	2516		1×CEE 16/2 2×16A/24V	3m, 2×1.5mm <sup>2</sup> with plug T13	1 thermal overcurrent protection switch	0.6A	
229713	320	6200		2×CEE 16/2 2×16A/24V	3m, 2×1.5mm <sup>2</sup> with plug T13	1 thermal overcurrent protection switch	1.6A	
229714	500	6200		2×CEE 16/2 2×16A/24V	3m, 2×1.5mm <sup>2</sup> with plug T13	1 thermal overcurrent protection switch	2.5A	
229715	1'000	6700		4×CEE 16/2 2×16A/24V	3m, 2×1.5mm <sup>2</sup> with plug T13	1 thermal overcurrent protection switch	5.0A	micro-fuse 16A
229716	2'500	7900		6×CEE 16/2 2×16A/24V	3m, 2×1.5mm <sup>2</sup> with plug T13	1 thermal overcurrent protection switch	12.0A	micro-fuse 16A
229717	1'500	3500		4×CEE 16/2 2×16A/24V	3m, 2×1.5mm <sup>2</sup> with plug T13	1 thermal overcurrent protection switch	7.0A	micro-fuse 16A
229718	2'000	3900		6×CEE 16/2 2×16A/24V	3m, 2×1.5mm <sup>2</sup> with plug T13	1 thermal overcurrent protection switch	10.0A	unimat*

\* Inrush current limiter 6×Unimat 1-16A

Other fitting options on request. For accessories such as stands, brackets, etc. see page 11.

## Power distribution trolley

This product can only be created as a result of discussion and exchange. Our experiences and your needs matched perfectly, produce the solution. The options are virtually limitless.

### Possible uses

- large-scale inspections
- assembly work
- large construction sites
- test an assembly sites in industry
- concerts and events
- theatres

### Some installation options

- transformers (three phase current, safety or isolating transformer)
- control elements
- measuring equipment (voltmeter, amperemeter)
- fuse elements
- indicator lamps
- insulation monitor
- plugs connectors, etc.



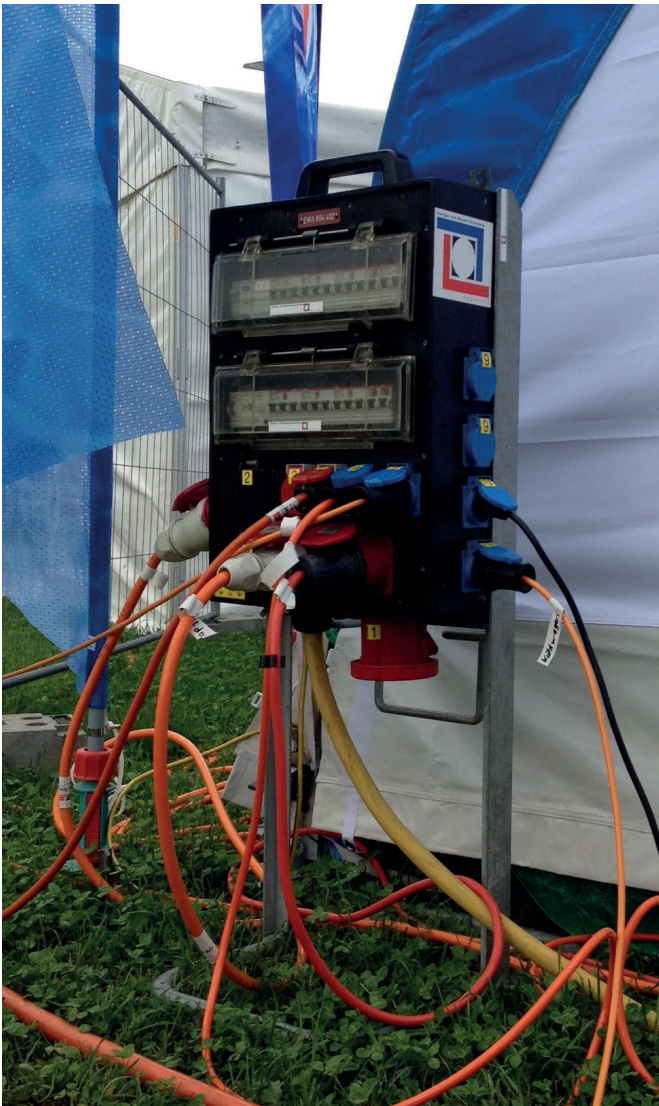

GET IN TOUCH WITH US

News about the assortment and specific solutions  
you can find on our website:

[www.gifas.ch](http://www.gifas.ch)



We reserve the right to make technical modifications. V 09/23

**GIFAS**  
ELECTRIC

GIFAS-ELECTRIC GmbH  
Dietrichstrasse 2  
CH-9424 Rheineck

+41 71 886 44 44  
+41 71 886 44 49  
info@gifas.ch  
www.gifas.ch